

Hand Held Instrument (1593 Series)

Plastic



KEY FEATURES

- Electronic instrument enclosures, ideally suited for mounting printed circuit boards.
- Ergonomically designed for a comfortable fit into the user's hand.
- Two piece lap joint construction provides protection against dust accumulation and splashing water.
- Molded in a choice of black or grey general purpose ABS plastic.
- Unit is secured with self-tapping screws.

ACCESSORIES



Replacement Screws

Package of 100 self-tapping #4 oval head:

1593KS100 .875" (22.2mm) for K, L & X

1593MS100 .625" (15.9mm) for S & T

1593QS100 .75" (19.1mm) for J, N, P, Q, D & Y



P.C. Board Screws

Self-tapping type, used for bosses in the 1591 lid for P.C. board installation. #4 x 1/4" (6.4 mm)

1593ATS50 - Package of 50

1593ATS100 - Package of 100



Belt or Pocket Clip

Molded from tough nylon, includes 2 nylon screws and mounting template.

Black - **1599CLIP**

Grey - **1599CLIPGY**

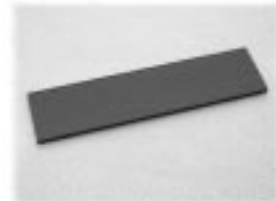

Optional Infrared Panel

Sold in packages of 10

1593DIR10 for 1593D

1593NIR10 for 1593N

1593PIR10 for 1593K, L, P, Q, Y & X

1593SIR10 for 1593S & T

Hand Held Instrument (1593 Series)

Plastic

Recessed top for membrane display or pad...

Four P.C. card standoffs molded in bottom...

Removable front & rear panels for easy modification (or replace with optional IR panel) - sized to accept most popular connectors...

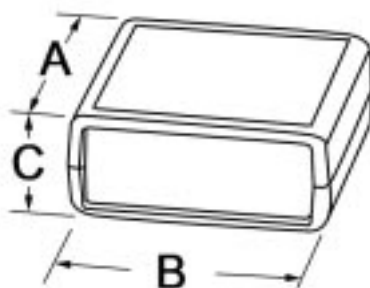

Part Number		Units	Dimensions			Battery Compartment	Front Open (w/panel)	Rear Open (w/panel)
Black	Grey		A	B	C			
1593KBK	1593KGY	inch mm	2.6 66	2.6 66	1.1 28	N	Y	Y
1593LBK	1593LGY	inch mm	3.6 92	2.6 66	1.1 28	N	Y	Y
1593NBK	1593NGY	inch mm	4.3 110	2.9 75	1.0 25	N	Y	Y
1593XBK	1593XGY	inch mm	5.5 140	2.6 66	1.1 28	N	Y	Y

NOTE: 1593N is designed to house the smart card readers.

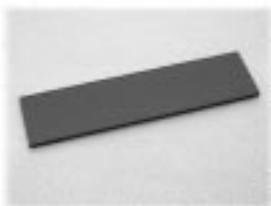

Optional Infrared Panel

Sold in packages of 10
1593NIR10 for 1593N
1593PIR10 for 1593K, L & X



Replacement Screws

Package of 100 self-tapping #4 oval head:
1593KS100 .875" (22.2mm) for K, L & X
1593QS100 .75" (19.1mm) for N



P.C. Board Screws

Self-tapping type, used for bosses in the 1591 lid for P.C. board installation. #4 x 1/4" (6.4 mm)
1593ATS50 - Package of 50
1593ATS100 - Package of 100



CANADA
 Guelph, Ontario (519) 822-2960
 St. Laurent, Quebec (514) 343-9010
USA
 Cheektowaga, NY (716) 651-0086

www.hammondmfg.com

EUROPE
 Basingstoke, UK +44 1256 812812

AUSTRALASIA
 Queenstown, SA, Australia +61 8 8240 2244

Hand Held Instrument (1593 Series)

Plastic

Recessed top for membrane display or pad...

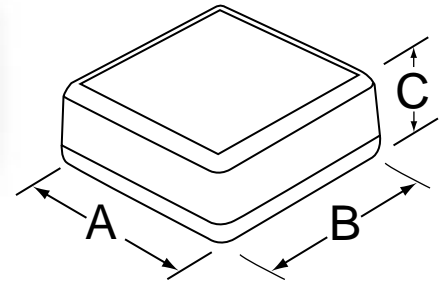
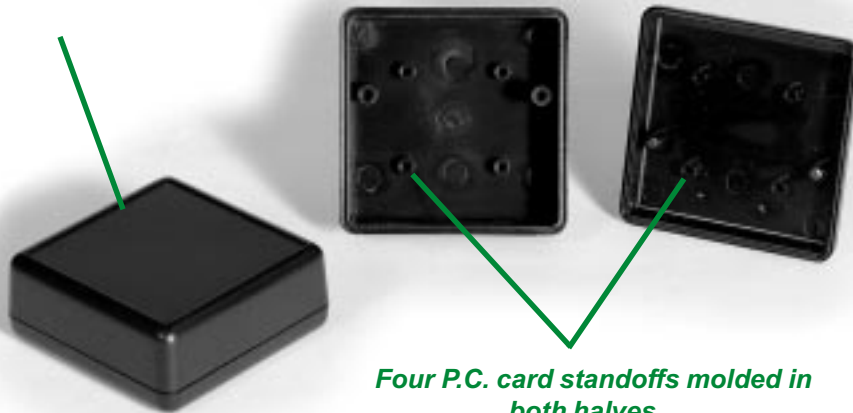

Four P.C. card standoffs molded in both halves...

Part Number		Units	Dimensions			Battery Compartment	Front Open (w/panel)	Rear Open (w/panel)
Black	Grey		A	B	C			
1593JBK	1593JGY	inch mm	2.6 66	2.6 66	1.1 28	N	N	N

Replacement Screws

Package of 100 self-tapping #4 oval head:
1593QS100 .75" (19.1mm)

PCB Screws

To mount P.C. boards into standoffs (#4 x 1/4" pan head screws)
1593ATS100 - Package of 100
1593ATS50 - Package of 50

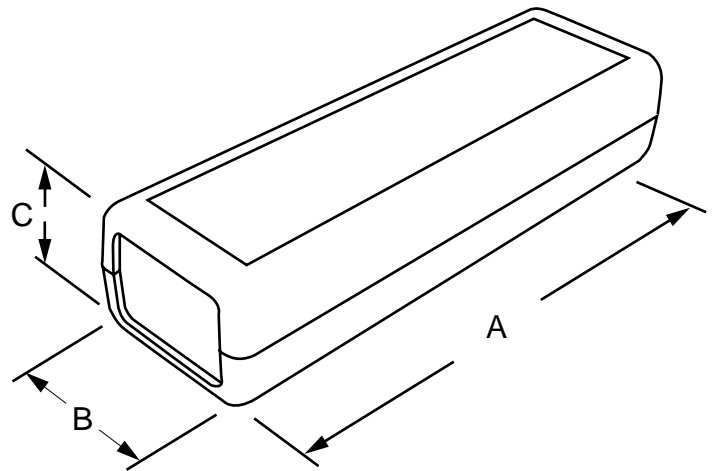

Part Number		Units	Dimensions			Battery Compartment	Front Open (w/panel)	Rear Open (w/panel)
Black	Grey		A	B	C			
1593DBK	1593DGY	inch mm	4.5 114	1.4 36	1.0 25	N	Y	Y

Optional Infrared Panel

1593DIR10 - Package of 10

Replacement Screws

Package of 100 self-tapping #4 oval head:
1593QS100 .75" (19.1mm)

PCB Screws

To mount P.C. boards into standoffs (#4 x 1/4" pan head screws)
1593ATS100 - Package of 100
1593ATS50 - Package of 50

Hand Held Instrument (1593 Series)

Plastic

Recessed top for membrane display or pad...

Four vertical P.C. card guides molded in...

Long life battery door with our "three snap" location door...

Removable front panel (or replace with optional IR panel) for easy modification - sized to accept most popular connectors...

P.C. card standoffs molded in both halves...

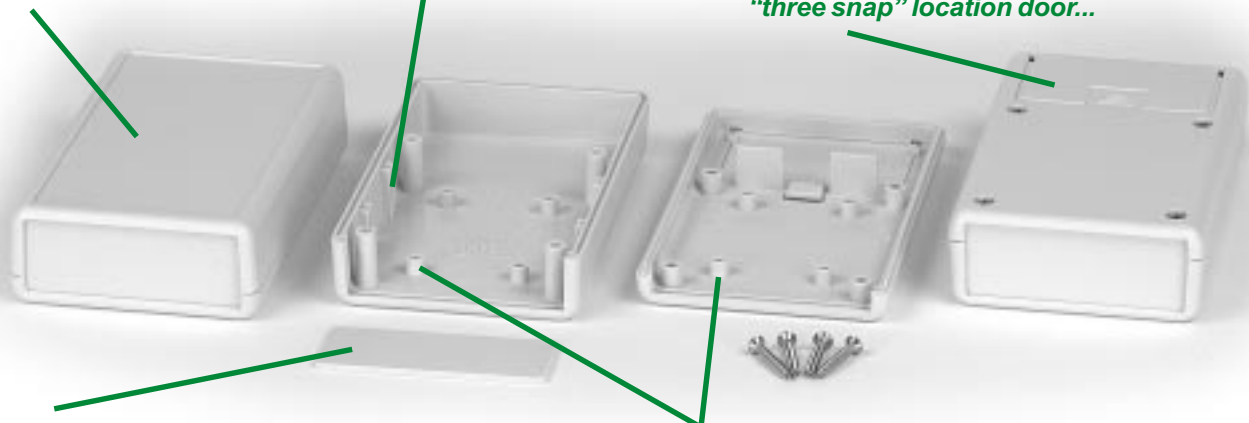

Part Number		Units	Dimensions			Battery Compartment	Front Open (w/panel)	Rear Open (w/panel)
Black	Grey		A	B	C			
1593SBK	1593SGY	inch mm	3.6 92	2.6 66	.83 21	Y*	Y	N
1593PBK	1593PGY	inch mm	3.6 92	2.6 66	1.1 28	Y	Y	N
1593TBK	1593TGY	inch mm	4.4 112	2.6 66	.83 21	Y*	Y	N
1593QBK	1593QGY	inch mm	4.4 112	2.6 66	1.1 28	Y	Y	N
1593YBK	1593YGY	inch mm	5.5 140	2.6 66	1.1 28	Y	Y	N

NOTES: * Due to their low profile design, the 1593S & 1593T models will not accept batteries larger than AAA.

Battery Holder Kits

- Designed for our battery door enclosures.
- Kits include all the parts required to install the batteries
- Kit includes the battery holder, wires, divider and foam anti-rattle pad.

Part Number	Battery holder kit for:
BH1AAWKIT	1 AA Cell
BH2AAWKIT	2 AA Cells
BH1AAAWKIT	1 AAA Cell
BH2AAAWKIT	2 AAA Cells
BH3AAAWKIT	3 AAA Cells
BH4AAAWKIT	4 AAA Cells
BS61KIT	1 - 9V Cell

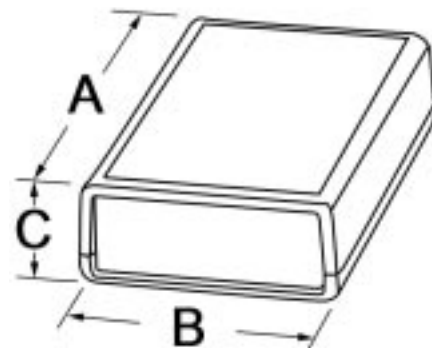

Optional Infrared Panel

Package of 10

- 1593PIR10 - for 1593P, Q & Y
1593SIR10 - for 1593S & T

Replacement Screws

Package of 100 self-tapping #4 oval head:

- 1593MS100 .625" (15.9mm) for 1593S & T
1593QS100 .75" (19.1mm) for 1593P, Q & Y

PCB Screws

To mount P.C. boards into standoffs

- (#4 x 1/4" pan head screws)
1593ATS100 - Package of 100
1593ATS50 - Package of 50



CANADA
Guelph, Ontario (519) 822-2960
St. Laurent, Quebec (514) 343-9010
USA
Cheektowaga, NY (716) 651-0086



EUROPE
Basingstoke, UK +44 1256 812812

AUSTRALASIA
Queenstown, SA, Australia +61 8 8240 2244